

LENS DESCRIPTION STANDARD VERSION 2.1

JUNE 2014

© 2014 **The Vision Council**

Developed by:

Lens Division of The Vision Council

Lens Description Standard Committee

The Vision Council
225 Reinekers Lane Suite 700
Alexandria, VA 22314
thevisioncouncil.org



THE **VISION**COUNCIL

Lens Description Standard

Version 2.1, June 2014

Table of Contents

1.	FOREWORD	3
2.	DEFINITIONS AND SIGN CONVENTION	4
3.	DESCRIBING LENS BLANK SPECIFICATIONS AND ATTRIBUTES	8
4.	DESCRIBING THE GEOMETRY OF NON-SPHERICAL SURFACES	20
5.	STANDARD FILE FORMAT EXAMPLES	24
6.	LITERAL ABBREVIATIONS	26

1. Foreword

1.1. Scope and Purpose

This Standard addresses the need for an industry-wide data file structure and related terminology. It is for use by lens manufacturers in describing the technical attributes of lenses. Suppliers of laboratory lens layout software use this data in the selection and processing of prescription lenses. Data describing the front surface geometry of non-spherical lenses is included to enable accurate control of lens thickness. This standard replaces the many proprietary file formats currently in use when supplying software vendors with lens specifications in electronic form.

The purpose of this Standard is twofold:

- Provide a consistent method and nomenclature for describing the specifications and attributes of both finished and semi-finished spectacle lens blanks as supplied by the lens vendor, and
- Provide a consistent and precise method for describing the geometry of non-spherical lens surfaces, including aspheric and progressive lens surfaces, to ensure accurate control of lens thickness during prescription processing.

1.2. Normative references

The following normative references contain additional terms, guidelines, optical & geometrical tolerances, and test methods that are applicable to this Standard. Wherever possible, the terms and guidelines presented in this Standard have been written in accordance with these references:

Standard for Device Communications, Vision Council

ANSI Z80.1, For Ophthalmic Optics — *Prescription Ophthalmic Lenses — Recommendations*, American National Standards Institute

ISO 10322-1, Ophthalmic Optics — *Semi-finished spectacle lens blanks: Specifications for single-vision and multifocal lens blanks*, International Standards Organization

ISO 10322-2, Ophthalmic Optics — *Semi-finished spectacle lens blanks: Specifications for progressive power lens blanks*, International Standards Organization

ISO 8980-1, Ophthalmic Optics — *Uncut finished spectacle lenses: Specifications for single-vision and multifocal lenses*, International Standards Organization

ISO 8980-2, Ophthalmic Optics — *Uncut finished spectacle lenses: Specifications for progressive power lenses*, International Standards Organization

1.3. Changes from prior version 2.0

The following changes have been incorporated in the current revision of the Lens Description Standard from the prior version (2.0) of this standard:

- ~~A Cat Code field has been added to uniquely identify a product above the OPC level.~~
- ~~The Lens Material classifications by refractive index have been modified.~~
- ~~A Filter Brand field has been added to identify the brand name of a tint or filter.~~
- ~~A Hor Diam field has been added to specify the minimum usable horizontal diameter of the lens.~~
- ~~Distance and Near Reference Point location fields for progressive lenses have been added.~~
- ~~The maximum text length of certain fields has increased.~~
- ~~New literals have been added to the Special field.~~
- A Nominal Diameter field has been added to address marked diameters.
- New Imbedded Object fields have been added to address products such as polarized lenses.

2. Definitions and Sign Convention

2.1. Glossary of terms and definitions

Throughout this Standard, the following terms, definitions, and abbreviations shall apply. Wherever possible, these definitions are consistent with ANSI and ISO definitions.

- 2.1.1. **ABBE VALUE** (abbr. **ABBE**): The Abbe value is the reciprocal of the relative dispersion of a lens material, and is a measure of the ability of the material to refract light into its various component wavelengths (or colors). The Abbe value v_d , is defined by the following formula:

$$v_d = \frac{\eta_d - 1}{\eta_F - \eta_C}$$

where η_d is the index of refraction of the helium d-line (587.56 nm), η_F is the index of refraction of the hydrogen F-line (486.13 nm), and η_C is the index of refraction of the hydrogen C-line (656.27 nm).

- 2.1.2. **BASE CURVE, NOMINAL** (abbr. **BASE**): The standard or reference curve in a lens or series of lenses, for example the manufacturer's marked or nominal tool surface power of the finished surface of a semi-finished spherical lens.
- 2.1.3. **CENTER, OPTICAL**: The point on the front surface of a lens intersected by the optical axis of the lens. This point is free from prismatic effects.
- 2.1.4. **CURVATURE, INSTANTANEOUS RADIUS OF** (abbr. **RAD**): The instantaneous radius of curvature, measured in millimeters (mm) is the radius of curvature specified by the manufacturer for power calculations.
- 2.1.5. **DENSITY**: The mass per unit volume of a lens material. For the purposes of this Standard, density should be expressed in units of grams per cubic centimeter (g/cc). Density—when expressed in this manner—is equivalent to specific gravity, which is a unit-less expression comparing a given volume of the material to an equal volume of water.
- 2.1.6. **DIOPTER**: A unit of measurement in inverse meters (plus or minus) used to express the power of a lens or lens surface. The symbol 'D' is used to designate the diopter.
- 2.1.7. **DIOPTER, PRISM**: A unit of measurement used to express the angle of deviation of a ray of light by a prism or lens. Prism power, in these units, is measured as the displacement of the ray, in centimeters, perpendicular to its line of incidence at a distance of one meter. The symbol Δ is used to designate the prism diopter.
- 2.1.8. **ENCROACHMENTS**: Any markings, physical alterations, or lenticular zones/ lips on a lens blank that may interfere with the optically usable area of the lens, unless otherwise defined.
- 2.1.9. **FILTER**: A lens material, treatment, or coating that absorbs, in whole or in part, some wavelengths of visible radiation (light) while transmitting others.
- 2.1.10. **FITTING CROSS** (abbr. **FC**): That point on a lens as specified by the manufacturer to be used as a reference point for positioning the lens in front of a patient's eye.
- 2.1.11. **INDEX OF REFRACTION** (abbr. **INDEX**): The ratio of the velocity of light (with a given wavelength) in air to that in a medium. This ratio expresses the ability of a lens material to refract or bend a ray of light. The index of refraction is given for a specified reference wavelength.
- 2.1.12. **INTERMEDIATE** (abbr. **INT**): For the purposes of this Standard, the area in a trifocal lens that has been designed and manufactured to correct vision at intermediate ranges. This is generally the upper segment of two.
- 2.1.13. **LENS(ES)**
- 2.1.13.1. **ASPHERIC**: A lens in which one or both surfaces are aspheric.
- 2.1.13.2. **BIFOCAL**: A multifocal lens designed to provide correction for two discrete distances.

- 2.1.13.3.BLENDED: A multifocal lens designed to provide correction for specific discrete viewing distances without sharply defined borders between optical areas.
- 2.1.13.4.FINISHED: A lens finished to its final form, including vertex powers and thickness.
- 2.1.13.5.LENTICULAR: A lens, usually of strong refractive power, in which the prescribed power is provided over only a limited central region of the lens, called the lenticular portion. The remainder of the lens is called the carrier and provides no refractive correction but gives dimension to the lens for mounting.
- 2.1.13.6.MINUS: A lens having negative refractive power. It is thinner at the center than at the edge and causes the divergence of a collimated beam of light.
- 2.1.13.7.MULTIFOCAL: A lens designed to provide correction for two or more discrete distances.
- 2.1.13.8.PLUS: A lens having positive refractive power. It is thicker at the center than at the edge and causes the convergence of a collimated beam of light.
- 2.1.13.9.PROGRESSIVE: A lens designed to provide correction for more than one viewing distance in which the power changes continuously rather than discretely.
- 2.1.13.10.SEMI-FINISHED: A lens having only one surface finished to a specific curve.
- 2.1.13.11.SINGLE VISION: A lens designed to provide correction for a single viewing distance.
- 2.1.13.12.SPHERICAL POWER: A lens that has the same refractive power in all meridians.
- 2.1.13.13.SPHERO-CYLINDER: A lens having different refractive power in the two principal meridians. It is sometimes referred to as an astigmatic or toric lens or, commonly though imprecisely, as a cylinder lens.
- 2.1.13.14.TRIFOCAL: A multifocal lens designed to provide correction for three discrete viewing distances.
- 2.1.14. MERIDIAN: A line of intersection of a surface with a plane perpendicular to that surface at a specified point. When applied to a lens, it may also be defined as a plane that contains the optical axis.
- 2.1.15. POWER
- 2.1.15.1.ADDITION (abbr. ADD): The difference in vertex power measurements between the near and distance reference points. The vertex (either front or back) of the surface containing the segment or addition is used.
- 2.1.15.2.CYLINDER (abbr. CYL): The difference (plus or minus) between powers measured in the two principal meridians of a sphero-cylinder lens. For the purposes of this Standard, cylinder power is the difference between the back vertex power measurements of the two principal meridians, as measured at the distance reference point of the lens blank.
- 2.1.15.3.PRISM: The ability of a prism or a lens to deviate a ray of light transmitted through it. It is the deviation of a ray normal to the back surface of a lens and penetrating the front surface at a specified point. The amount of deviation is expressed in prism diopter units.
- 2.1.15.4.REFRACTIVE SURFACE: The refractive surface power (F_s) of a lens surface bounded by air is a measure of its ability to change the vergence of a beam of incident light and is defined as follows:

$$F_s = \frac{\eta_d - 1}{r}$$

where η_d is the index of refraction of the lens material using the helium d-line as the reference wavelength and r is the radius of curvature of the refracting surface in millimeters.

- 2.1.15.5.SPHERE (abbr. SPH): In a spherical lens, the dioptric power of a lens. In a sphero-cylinder lens, the sphere power is located in the cylinder axis meridian, which is the meridian containing the least minus or most plus power. For the purposes of this

Standard, sphere power is the back vertex power measurement of the sphere principal meridian, as measured at the distance reference point of the lens blank.

2.1.15.6. VERTEX: The inverse of the distance, expressed in meters, from either the front or back lens vertex to the corresponding focal point of the reference wavelength. This is expressed in diopters. In a distance prescription, the spherical component of power and the cylindrical component of power are always expressed in terms back vertex power. The add power is generally expressed in terms of front vertex power for most multifocal lenses. The back vertex power F_V is defined using the equation:

$$F_V = \frac{F_1}{1 - \frac{t}{\eta_d} F_1} + F_2$$

where F_1 and F_2 are the front and back surface powers (respectively), t is the center thickness of the lens in meters, and η_d is the index of refraction of the lens material.

2.1.16. REFERENCE POINT

2.1.16.1. DISTANCE (abbr. DRP): That point on a lens as specified by the manufacturer at which the distance sphere power, cylinder power, and axis shall be measured.

2.1.16.2. LAYOUT (abbr. LRP): That point on a lens as specified by the manufacturer that is used as a reference point for positioning the lens in front of the wearer's eye. For progressive addition lenses, the LRP is coincident with the fitting cross (FC). For conventional multifocals, the LRP is coincident with the location of the segment. For single vision lenses, the LRP is the geometric center (GC) of the lens blank, unless otherwise specified (e.g., decentered single vision aspheric lenses).

2.1.16.3. NEAR (abbr. NRP): That point on a multifocal or progressive lens as specified by the manufacturer at which the addition power is measured.

2.1.16.4. PRISM (abbr. PRP): That point on a lens as specified by the manufacturer at which the prism value of the finished lens is to be measured. For progressive lenses, the prism reference point is located at the midpoint between the semi-visible alignment reference markings (or "engravings"), separated by a distance of 34 mm, along a horizontal axis bisecting those two markings. For non-aspheric single vision and multifocal lenses, the prism reference point and distance reference point are assumed to be coincident.

2.1.17. REFERENCE WAVELENGTH: The reference wavelength used in the United States and in this Standard is the helium d-line (at 587.56 nm). For the purposes of this Standard, surface power, vertex power, and Abbé value should be provided using the helium d-line reference system. The mercury e-line (at 546.07 nm) is also used as a reference wavelength in some countries.

2.1.18. SAGITTA (abbr. SAG): The height or depth of a curve at a given diameter.

2.1.19. SEGMENT (abbr. SEG): A specified area of a multifocal lens having a different refractive power from the distance portion. This may also refer to the actual piece of material added to the lens in the case of a fused or cemented multifocal lens.

2.1.20. SLAB-OFF and REVERSE SLAB-OFF (abbr. SLAB): A prismatic component incorporated by bicentric grinding or molding into the lower portion of an ophthalmic lens to modify the amount of vertical prism for a line of sight through that portion of the lens.

2.1.21. SPECIFIC GRAVITY: See Density.

2.1.22. SURFACE

2.1.22.1. ASPHERIC: A non-spherical surface that is rotationally symmetrical with respect to an axis of symmetry. Such surfaces typically have continuously variable curvatures from the vertex to the periphery.

2.1.22.2. ATORIC: A surface having mutually perpendicular principal meridians of unequal power where at least one principal meridian has a non-circular section. These surfaces are symmetrical with respect to both principal meridians.

2.1.22.3.SPHERICAL: A curved surface having the same radius of curvature in all meridians.

2.1.22.4.TORIC: A surface in the form of a torus having different powers in the two principal meridians. The shape may be visualized as a small part of the surface of a doughnut or of a football. A toric surface is generated by rotating an arc of a circle around an axis which does not pass through the center of the circle.

2.2. Sign convention

The following sign convention and numerical precision is used throughout this Standard:

- For the purposes of this Standard, **numerical values** refer to either *floating point numbers* or *integers* (when no decimal precision is required), **text entries** refer to *character* or *string* data, and **literals** refer to designated, predefined combinations of characters having a specified length.
- Text* entries in record fields should not contain commas ‘,’.
- Unsigned (\pm) numerical values shall be interpreted as being positive (+).
- Negative (-) numerical values shall include a minus (-) sign in all field entries.
- Convex front curves and concave back curves shall require a positive (+) radius.
- Concave front curves and convex back curves shall require a negative (-) radius.
- For numerical values, the precision shall be indicated by the decimal place requirement as specified in that particular field’s data type.
- The *layout reference point* (LRP) location values shall be specified relative to the *geometric center* (GC) of the *right lens blank* according to this sign convention:

Right Lens System (mm)	In (Right) From GC	Out (Left) From GC	Above From GC	Below From GC
LRP (In / Down)	Positive (+)	Negative (-)	Negative (-)	Positive (+)

- The *prism reference point* (PRP) location values shall be specified relative to the *layout reference point* (LRP) of the *right lens blank* as follows:

Right Lens System (mm)	In (Right) From LRP	Out (Left) From LRP	Above From LRP	Below From LRP
PRP (Out / Up)	Negative (-)	Positive (+)	Positive (+)	Negative (-)

- The *distance reference point* (DRP) location values shall be specified relative to the *prism reference point* (PRP) of the *right lens blank* as follows:

Right Lens System (mm)	In (Right) From PRP	Out (Left) From PRP	Above From PRP	Below From PRP
DRP (In / Up)	Positive (+)	Negative (-)	Positive (+)	Negative (-)

- The *near reference point* (NRP) location values shall be specified relative to the *prism reference point* (PRP) of the *right lens blank* as follows:

Right Lens System (mm)	In (Right) From PRP	Out (Left) From PRP	Above From PRP	Below From PRP
NRP (In / Up)	Positive (+)	Negative (-)	Positive (+)	Negative (-)

3. Describing Lens Blank Specifications and Attributes

The optical and geometrical (physical) attributes of a lens blank shall be described using the format and conventions specified below. Records for new products, deleted products, and/or modified products may be provided in incremental form within a separate file.

3.1. Field definitions and requirements for each record

#	?	Field Label	Description / Definition	Literals	Data Type
1	M	MFG*	Unique Manufacturer Identifier	See 6.2	Literal, 6-character max
2	M	Class	Finished Finished / Extra Thin Semi-Finished Semi-Fin / Extra Thick	FIN FNT SFN SFX	Literal, 3-characters
3	M	Description	Product Description		Text, 255-character max
4	M	Material	Glass Glass Mid-Index (n > 1.53) Glass High-Index (n > 1.59) Glass Ultra-Index (n > 1.65) Plastic Plastic Mid-Index (n > 1.53) Plastic High-Index (n > 1.59) Plastic Ultra-Index (n > 1.65) Polycarbonate Other Plastic	GL GM GH GU PL PM PH PU PY OP	Literal, 2-characters
5	M	Material Brand	Material Brand Name		Text, 255-character max
6	M	Product Name	Product Brand Name		Text, 255-character max
7	M	Style	Single Vision Bifocal Trifocal Quadrifocal Progressive Double/Dual Segment 40% Intermediate 60% Intermediate 70% Intermediate Flat-Top Executive-Style Curve-Top Round Task-Specific Aspheric Atoric Lenticular	SV BI TR QD PR DS 40 60 70 FT EX CT RD TS AS AT LT	Multiple literals, 2 characters each separated by spaces NOTE: Multiple literals, when used, shall appear in the sequence provided in this list.

* See page Section 6.0 for creating additional literal abbreviations.

#	?	Field Label	Description / Definition	Literals	Data Type
8	M	Filter	Clear (DEFAULT) Mirrored Photochromic Polarized Tinted UV-Inhibiting Tint Color	NONE MIRR PHOT POLR TINT UVRI See 6.1	Multiple literals, 4- characters each separated by spaces
9	M	Coating	Un-Coated (DEFAULT) Anti-Reflective Coating Scratch-Resistant Coating	UC AR SR	Multiple literals, 2- characters each separated by spaces
10	M	Coating Brand	Coating Brand Name		Text, 255-character max
11	M	Right OPC	Right Eye Optical Product Code		Text, 10-character
12	M	Left OPC	Left Eye Optical Product Code		Text, 10-character
13	M	Diameter	Maximum Diameter of Blank		Numeric, 0-decimal
14	M	Sph / Base	Sphere Power for FIN Lenses; Nominal Base for SFN Lenses		Numeric, 2-decimal <i>In diopters</i>
15	M	Cyl / Add	Cylinder Power for FIN Lenses; Addition Power for SFN Lenses		Numeric, 2-decimal <i>In diopters</i>
16	M	Frnt Rad	Front Curve Radius for Power		Numeric, 3-decimal
17	M	Bck Rad	Back Curve Radius		Numeric, 3-decimal
18	M	C Thk	Center Thickness		Numeric, 1-decimal
19	M	E Thk	Edge Thickness		Numeric, 1-decimal
20	M	LRP In	Horizontal Location of LRP		Numeric, 1-decimal
21	M	LRP Down	Vertical Location of LRP		Numeric, 1-decimal
22	M	d Index	Refractive Index of He d-line		Numeric, 3-decimal
23	M	N Ref	Helium d Reference System Mercury e Reference System	ND NE	2-character literal
24		e Index	Refractive Index of Hg e-line		Numeric, 3-decimal
25		Abbe	Abbe Value		Numeric, 0-decimal
26		Density	Density of Lens Material		Numeric, 2-decimal
27		PRP Out	Horizontal Location of PRP		Numeric, 1-decimal
28		PRP Up	Vertical Location of PRP		Numeric, 1-decimal
29		Seg Wd	Width of Widest Part of Seg		Numeric, 1-decimal
30		Seg Thk	Fused Glass Seg Thickness		Numeric, 1-decimal
31		Int Ht	Height of Trifocal Intermediate		Numeric, 0-decimal
32		Slab	Slab-off Value (Prism Diopters)		Numeric, 2-decimal
33		Car Rad	Radius of Lentic Carrier Curve		Numeric, 3-decimal
34		Bwl Diam	Bowl Diameter of Lenticular		Numeric, 0-decimal
35		Ver Diam	Minimum Vertical Diameter		Numeric, 0-decimal
36		Dia Diam	Diagonal Diameter		Deprecated (Blank)

#	?	Field Label	Description / Definition	Literals	Data Type
37		Seg Sep	Separation of Dual Segments		Numeric, 1-decimal
38		Up Add	Upper Add Power of Dual Seg		Numeric, 2-decimal
39		Special	Product <i>Non-A/R</i> Compatible Product <i>Non-Tintable</i> Lip Encroachment Polarized Mark Encroachment 'Optimal' Rectangular Blank Embedded Object	NAR NTN LIP POL OPT OBJ	Multiple literals, 3 characters each separated by spaces
40	M	Cat Code	Unique Product Identifier		Text, 16-character max
41	M	Filter Brand	Filter Brand Name		Text, 255-character max
42		DRP In	Horizontal Location of DRP		Numeric, 1-decimal
43		DRP Up	Vertical Location of DRP		Numeric, 1-decimal
44		NRP In	Horizontal Location of NRP		Numeric, 1-decimal
45		NRP Up	Vertical Location of NRP		Numeric, 1-decimal
46		Hor Diam	Minimum Horizontal Diameter		Numeric, 0-decimal
47		Nom Diam	Nominal or Marked Diameter		Numeric, 0-decimal
48		Obj Clear	Imbedded Object Clearance		Numeric, 1-decimal
49		Obj Rad	Imbedded Object Radius		Numeric, 2-decimal

3.2. Guidelines for specifying lens blank attributes using a comma-delimited file format

The data described herein shall be contained in an ASCII text file, which is a stream of eight-bit ASCII characters constrained to the range of 32 to 127 (the set of printable characters) and the control characters “CR” (carriage return), “LF” (line feed), and “SUB” (used to mark the end of an MS-DOS text file). Carriage return/line feed pairs divide the file into lines, each of which comprises a **record**, which contains data for a particular lens or, in the case of *chiral* lenses that exhibit “handedness,” for a pair of lenses. Each *record* is divided into **fields**, delimited by commas. The characteristics of each *field* are described in the table below. *Character* field entries (either *literals* or *text*) shall be enclosed in double quotation marks (i.e., “”). The first record shall be a header row containing *all* of the field labels, as indicated below.

The following data field entries shall be provided in the order shown below. The field’s label—as it should appear in the file—is provided, as well as a description / definition of the field, the type of entry data that should be supplied in the field, and any *literal* entries that should appear in the field. Certain fields may not be applicable for all lens styles and should be left blank, which shall be expressed as adjacent commas (i.e., “,”). Fields that shall generally require an entry for most, though not necessarily all, spectacle lenses of any style or type have been indicated in the “?” column with the letter ‘M’ for *mandatory*. When a field is applicable but is intentionally left blank—that is, “,”—the *default* value, if any, shall be assumed.

3.3. Guidelines for specifying geometrical (physical) measurements of lens blanks

The physical specifications for the geometry of lens blanks, the geometry of lens blanks, and the location of multifocals segments within the lens shall be provided using the methods and conventions described below. Numeric values and text should adhere to the sign convention developed in Section 2.2. All physical distances shall be expressed in millimeters (mm). For “Plano” surfaces with zero curvature, which have an infinitely long radius of curvature, the radius shall be expressed as zero (0).

3.3.1. Specifying surface power by radius

3.3.1.1. Front curve surface power (Frnt Rad)

The front curve surface power, which is the value used for surfacing power calculations, shall be specified using the instantaneous radius of curvature of the front surface at the

distance reference point (DRP) of the lens blank. This has been illustrated in Figure 1. Note that convex front curves have a positive radius while concave front curves have a negative radius.

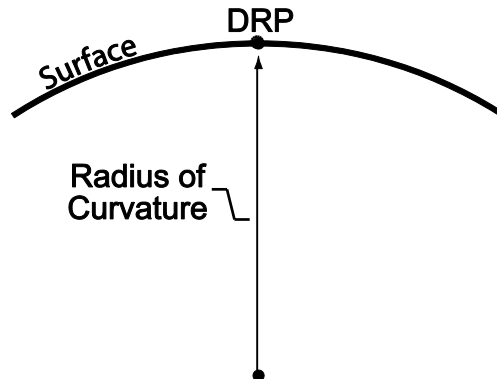

Figure 1 Instantaneous radius of curvature

3.3.1.2. Back curve surface power (Bck Rad)

The back curve surface power shall be specified using the radius of curvature of the rear surface at either the distance reference point (DRP) or the geometric center of the lens blank. Note that concave back curves have a positive radius while convex back curves have a negative radius. This value is recommended but not required for finished lens blanks. When this value is supplied for finished lens blanks with cylinder power, the radius of curvature provided shall be that through the principal meridian of the lens containing the specified sphere power (Sph).

3.3.1.3. Lenticular curve surface power (Car Rad)

The lenticular curve surface power shall be specified using the radius of curvature of the front lenticular surface within the carrier zone of the lens blank.

3.3.2. Specifying lens blank center thickness (C Thk)

The center thickness of the lens blank shall be specified as the thickness of the blank at its geometric center, measured normal (perpendicular) to the front and back surfaces. This measurement has been illustrated in Figure 2. The *mean* (or average) center thickness shall be provided from a statistically-significant sample population of the lens blanks. This value is *not* required for *finished* lens blanks whose nominal edge thickness is less than the center thickness (e.g., plus-powered lenses).

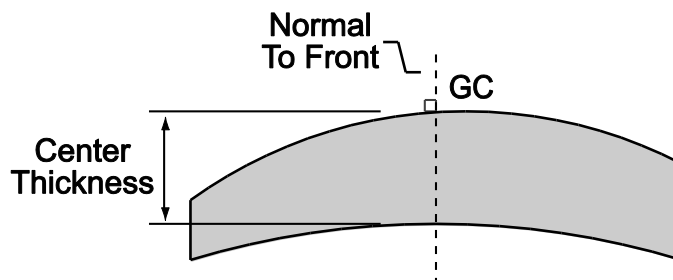

Figure 2 Center thickness of a (progressive) lens blank

3.3.3. Specifying lens blank edge thickness (E Thk)

The edge thickness of semi-finished lens blanks shall be specified as the thickness of the blank at its uppermost vertical (90°) edge, measured parallel to an imaginary axis passing through the geometric center of the lens blank and normal to the front surface. This measurement has been illustrated in Figure 3. The mean (or average) edge thickness shall be provided from a statistically-significant sample population of the lens blanks. This value is recommended but not required for finished lens blanks. When this value is supplied for finished lens blanks, the edge

thickness provided shall be that at the meridian of the lens containing the sphere power specified in field 14 (Sph).

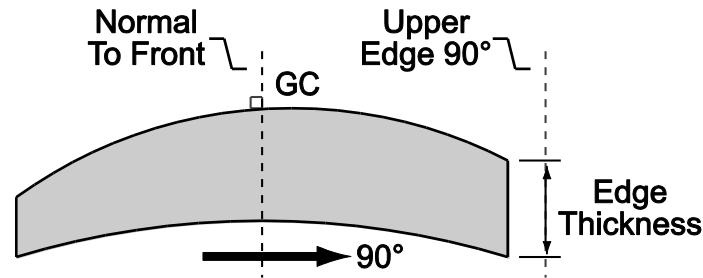

Figure 3 Edge thickness of a (progressive) lens blank

3.3.4. Specifying layout reference point location (LRP In and LRP Down)

The location of the *layout reference point* (LRP), which includes the segment of conventional multifocal lenses and the fitting cross of progressive addition lenses, shall be specified relative to the *geometric center* (GC) of the lens blank, using the sign convention described in Section 2.2.

For flat-top, curve-top, Executive-style, and similar multifocal lenses, **LRP In** shall be specified as the horizontal location and **LRP Down** shall be specified as the vertical location of the segment, relative to the geometric center of the lens blank. *LRP In* represents the horizontal separation, as measured parallel to the uppermost edge (or border) of the segment, between the geometric center of the lens blank and a vertical axis that bisects the geometric center of the segment (SC). *LRP Down* refers to the vertical separation, as measured parallel to a vertical axis that bisects the geometric center of the segment, between the geometric center of the lens blank and a horizontal line that is tangent to the uppermost edge (or border) of the segment. These measurements have been illustrated in Figure 4.

For single vision lenses, the *LRP In* and *LRP Down* shall be assumed to be coincident with the geometric center of the lens blank, unless otherwise specified (e.g., for decentered single vision aspheric lenses).

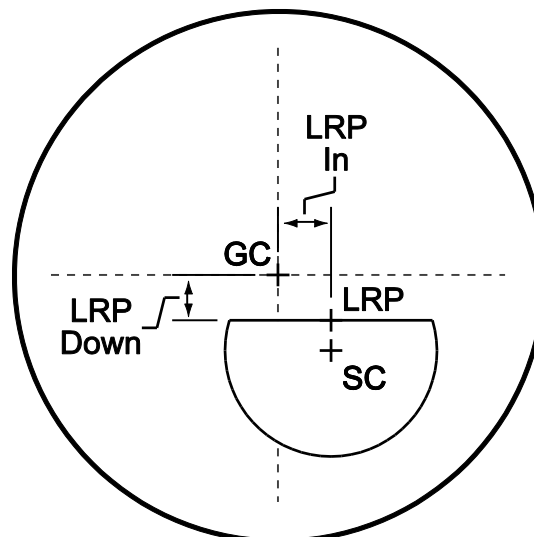

Figure 4 Layout reference point location of a lined multifocal lens blank

For progressive lenses, *LRP In* shall be specified as the horizontal location and *LRP Down* shall be specified as the vertical location of the fitting cross, relative to the geometric center of the lens blank. Since the fitting cross of most progressive addition lenses is located *above* the geometric center, the *LRP Down* value for such lenses will typically be *negative* (-). These measurements have been illustrated in Figure 5 for a decentered lens blank.

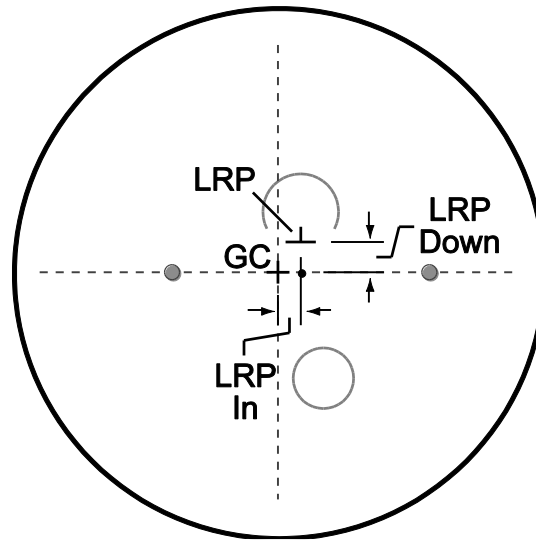

Figure 5 Layout reference point location of a progressive addition lens blank

For round and blended multifocal lenses, *LRP Down* shall be specified as the vertical location of the segment, relative to the geometric center of the lens blank. For such lenses, **LRP Down** is the minimum separation (or the shortest distance) between the geometric center of the lens blank the uppermost edge of the segment boundary or ink markings (if blended). An *LRP In* measurement is not necessary, since these lenses require no initial horizontal orientation. The *LRP Down* measurements are illustrated in Figure 6.

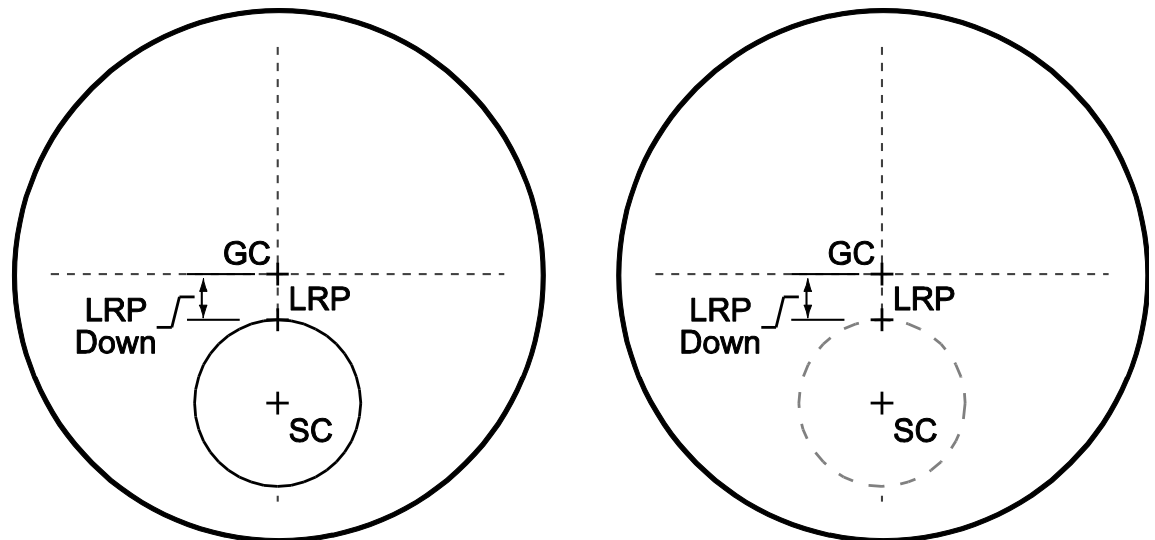

Figure 6 Layout reference point location of round and blended multifocal lens blanks

3.3.5. Specifying prism reference point location (PRP Out and PRP Up)

The location of the *prism reference point* (PRP) shall be specified relative to the *layout reference point* (LRP) of the lens blank using the sign convention described in Section 2.2.

PRP Out shall be specified as the horizontal location and **PRP Up** shall be specified as the vertical location of the prism reference point, relative to the layout reference point of the lens blank. *PRP Out* represents the horizontal separation, as measured parallel to a horizontal axis that intersects the prism reference point, between the layout reference point of the lens blank and a vertical axis that intersects the prism reference point. *PRP Up* refers to the vertical separation, as measured parallel to a vertical axis that intersects the prism reference point, between the layout reference point of the lens blank and a horizontal axis that intersects the prism reference point.

Although spherical, semi-finished single vision and multifocal lenses will typically not have a prism reference point specified by the manufacturer, progressive, aspheric, and finished multifocal lenses generally should have a PRP location specified. When no separate prism reference point is specified, it shall be assumed to coincide with the layout reference point of the lens blank. The prism reference point location of a progressive lens blank is illustrated in Figure 7.

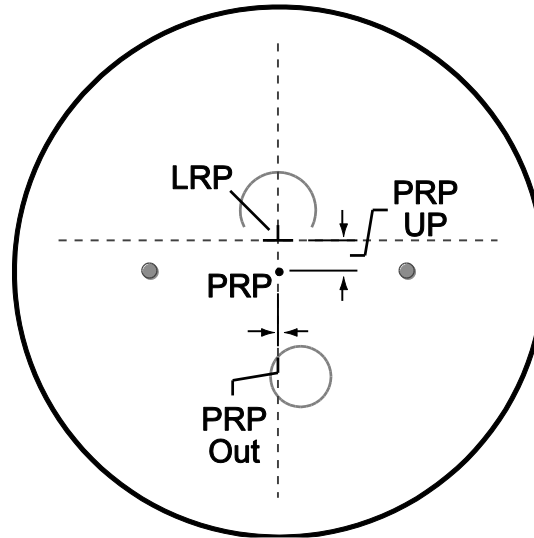

Figure 7 Prism reference point location of a progressive lens blank

3.3.6. Specifying distance and near reference point locations (DRP In, DRP Up, NRP In, and NRP Up)

The location of the *distance reference point* (DRP) and *near reference point* (NRP) shall be specified relative to the *prism reference point* (PRP) of the lens blank using the sign convention described in Section 2.2.

DRP In shall be specified as the horizontal location and **DRP Up** shall be specified as the vertical location of the distance reference point, relative to the prism reference point of the lens blank. *DRP In* represents the horizontal separation, as measured parallel to a horizontal axis that intersects the distance reference point, between the prism reference point of the lens blank and a vertical axis that intersects the distance reference point. *DRP Up* refers to the vertical separation, as measured parallel to a vertical axis that intersects the distance reference point, between the prism reference point of the lens blank and a horizontal axis that intersects the distance reference point.

NRP In shall be specified as the horizontal location and **NRP Up** shall be specified as the vertical location of the near reference point, relative to the prism reference point of the lens blank. *NRP In* represents the horizontal separation, as measured parallel to a horizontal axis that intersects the near reference point, between the prism reference point of the lens blank and a vertical axis that intersects the near reference point. *NRP Up* refers to the vertical separation, as measured parallel to a vertical axis that intersects the near reference point, between the prism reference point of the lens blank and a horizontal axis that intersects the near reference point.

Although single vision and multifocal lenses will frequently not have distance or near reference points specified by the manufacturer, general-purpose progressive lenses shall have both DRP and NRP locations specified. For certain task-specific progressive lenses, however, separate DRP and NRP locations may not exist. The distance and near reference point locations of a general-purpose progressive lens blank are illustrated in Figure 8.

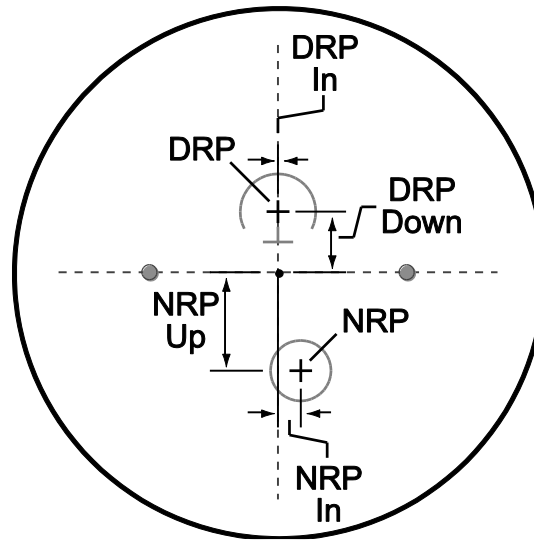

Figure 8 Distance and near reference point locations of a progressive lens blank

3.3.7. Specifying bowl diameter (Bwl Diam)

The **bowl diameter** of a lenticulated lens blank (for example, a 40-mm post-cataract lens) shall be specified as the widest horizontal dimension of the bowl, which is the central optically-usable zone. This is the horizontal distance between two parallel lines tangent to the right and left outermost edges of the bowl. This is illustrated in Figure 9.

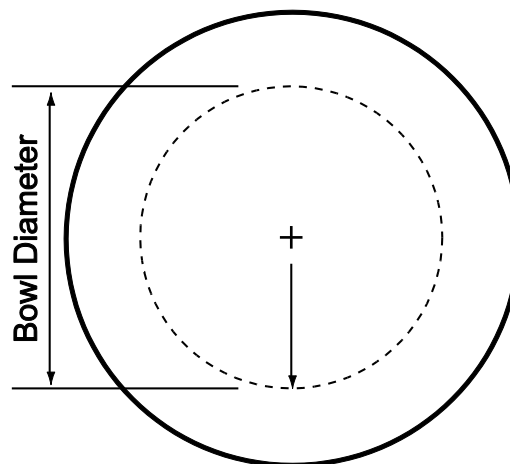

Figure 9 Specifying the bowl diameter of a lenticulated lens blank

3.3.8. Specifying blank diameter (Diameter, Ver Diam, Hor Diam, and Nom Diam)

The **diameter** of the lens blank shall be specified as the widest horizontal dimension of the blank. This is the horizontal distance between two parallel lines tangent to the right and left outermost edges of the lens blank, regardless of the presence of any encroachments or other physical limitations. This is illustrated in Figure 10, for two different lens blank shapes.

Additionally, a **marked** or **nominal diameter** (Nom Diam) field is available in order to allow the lens manufacturer to specify a value that does not necessarily comply with the physical definition of the Diameter field, provided above. For example, the nominal diameter (Nom Diam) provided on the lens packaging label or used to identify the lens blank in an order entry system may differ from the physical diameter (Diameter).

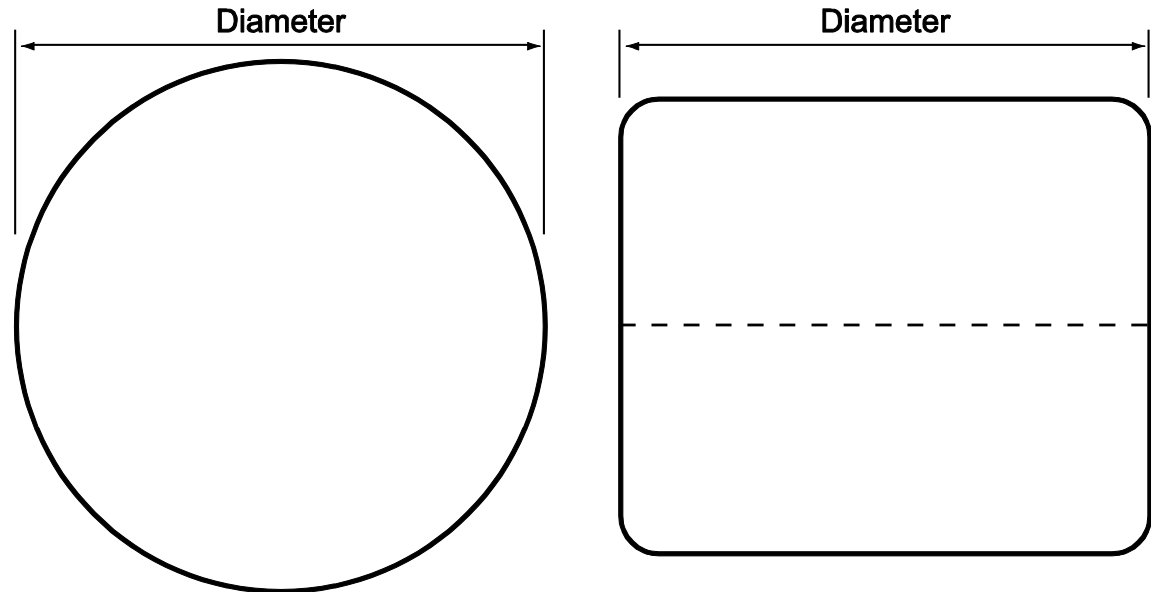

Figure 10 Specifying the *diameter* of a lens blank

For lens blanks with a vertical dimension that differs from the horizontal dimension or lens blanks with physical encroachments that limit the usable size of the lens blank in one or more dimensions, including lenticular lips for progressive lenses and horizontal alignment marks for polarized lenses, additional measurements can be provided. Additionally, the type of encroachment should be identified using the appropriate literal in the **Special** field. For lens blanks with physical encroachments in the horizontal meridian, the **horizontal diameter** (Hor Diam) shall be specified as the twice the shortest distance from the geometric center (GC) of the lens blank to any physical encroachment that obstruct the optical use of the lens blank along a horizontal (180°) axis containing the geometric center. These diameter measurements are illustrated in Figure 11. When no encroachments are present, this measurement is equal to the diameter measurement and is therefore not required.

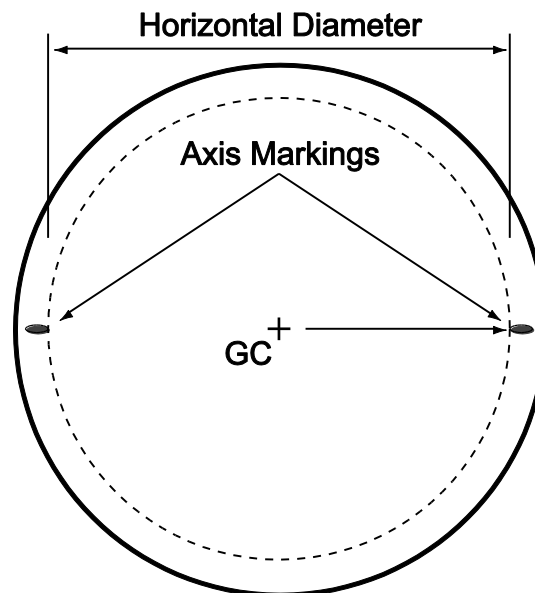

Figure 11 Specifying the *horizontal diameter* of a lens blank

For lens blanks with a vertical dimension that differs from the horizontal dimension, the **vertical diameter** (Ver Diam) shall be specified as the tallest vertical dimension of the lens blank. For lens blanks with physical encroachments in the vertical meridian, the **vertical diameter** (Ver Diam) shall be specified as the twice the shortest distance from the geometric center (GC) of the

lens blank to any physical encroachment that obstructs the optical use of the lens blank along a vertical (90°) axis containing the geometric center. These diameter measurements are illustrated in Figure 12.

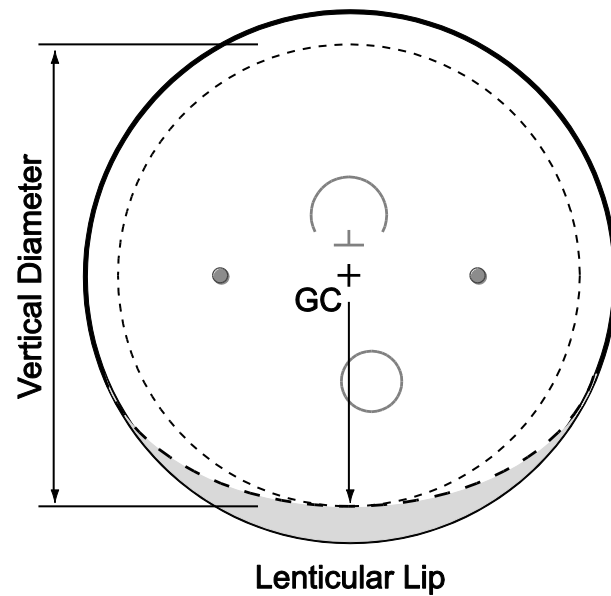

Figure 12 Specifying the *vertical* diameter of a lens blank

3.3.9. Specifying segment geometry

3.3.9.1. Lined multifocal segment width (Seg Wd)

The width of lined multifocal segments, with the exception of full-width or Executive-style lenses, shall be specified as the widest horizontal dimension of the segment. This is the horizontal distance between two parallel lines tangent to the right and left outermost edges of the segment boundary or ink markings (if blended), as illustrated in Figure 13.

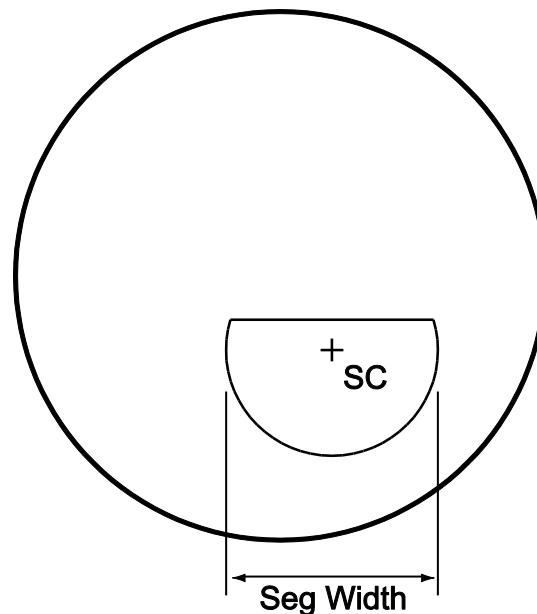

Figure 13 Specifying the segment width of a lined (flat-top) multifocal

3.3.9.2. Lined trifocal intermediate height (Int Ht)

The intermediate height of lined trifocal segments shall be specified as the minimum vertical separation between a line tangent to the uppermost edge (or border) of the bifocal

segment and a horizontal line tangent to the uppermost edge (or border) of the trifocal segment, as illustrated in Figure 14.

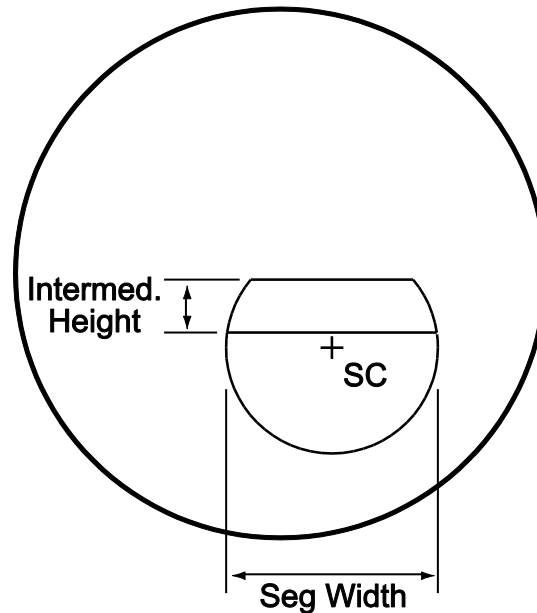

Figure 14 Intermediate height of a lined (flat-top) trifocal lens

3.3.9.3. Fused glass segment thickness (Seg Thk)

The segment thickness of fused glass multifocal lenses shall be specified as the thickness of the segment button at the optical center of the segment. (Note that this is not the resultant optical center of the combined segment and distance portion.)

3.3.10. Specifying the geometry an imbedded object (Obj Clear and Obj Rad)

For semi-finished lens blanks that have a polarized film, laminate layer, or other *imbedded object* within the lens blank that must be avoided during the lens surfacing process, dimensions may be specified to characterize the three-dimensional region of the lens blank that should be excluded from lens surfacing, relative to the front surface.

The **object clearance** shall be specified as the minimum distance to use for lens surfacing calculations from the front surface of the lens blank along an axis perpendicular to the front surface at the geometric center (GC) of the lens blank. Unless otherwise specified, the object clearance represents a uniform distance from the front surface over the entire lens blank, so that the rear boundary of the imbedded object region is nominally equally to the front surface curve of the lens blank, as illustrated in Figure 15.

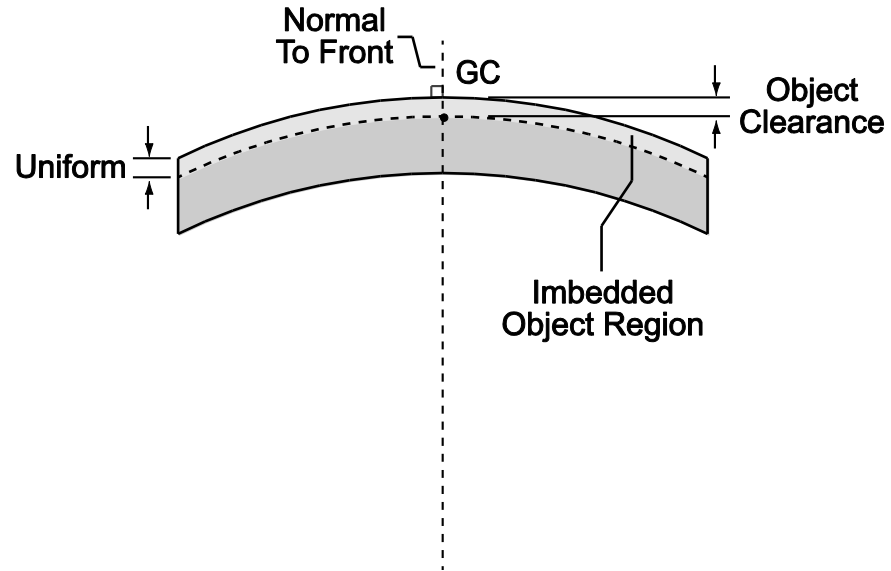

Figure 15 Specifying the uniform *clearance* of an object imbedded within the lens blank

Additionally, an optional parameter may be specified that defines the rear curve of the imbedded object region, when a uniform clearance from the front surface will not suffice. The **object radius** shall be specified as the radius of the spherical curve that bounds the three-dimensional region to exclude from lens surfacing as measured from the object clearance distance along an axis perpendicular to the front surface at the geometric center. For imbedded objects with known curvature, such as a film or layer that follows the nominal shape of the front surface of the lens blank, the object radius may be defined by this curvature as illustrated in Figure 16. If an object radius is not specified, the object clearance distance shall be assumed to be uniform (equidistant from the front surface) over the lens blank.

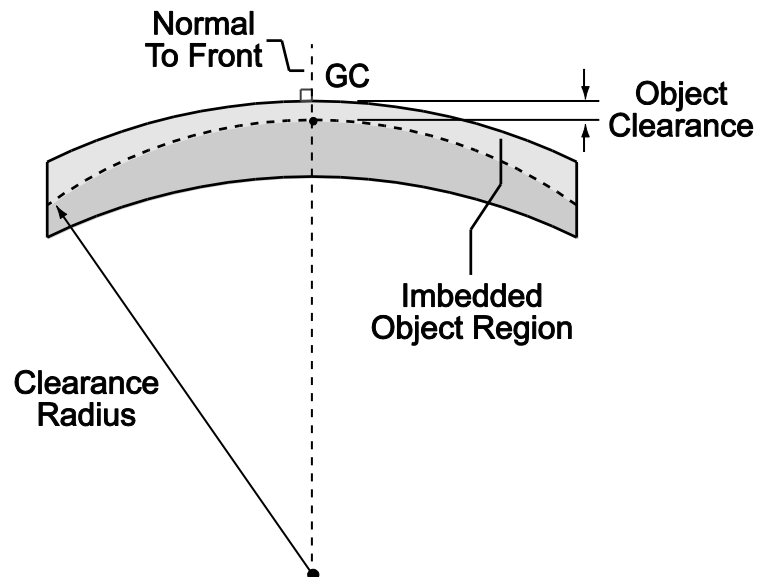

Figure 16 Specifying the *radius* of an object imbedded within the lens blank

4. Describing the Geometry of Non-Spherical Surfaces

The geometry of non-spherical surfaces, including aspheric and progressive addition lens surfaces, shall be described using sag height data as specified below. Please note that the format described below applies specifically to sag height data provided in electronic (file) form.

4.1. Guidelines and file format for describing the geometry of non-spherical surfaces

The data described herein shall be contained in an ASCII text file, which is a stream of eight-bit ASCII characters constrained to the range of 32 to 127 (the set of printable characters) and the control characters “CR” (carriage return), “LF” (line feed), and “SUB” (used to mark the end of an MS-DOS text file). Carriage return/line feed pairs divide the file into lines, each of which comprises a **record**, which contains sag data for various points on the lens blank. Each *record* is divided into **fields**, delimited by commas. The characteristics of each *field* are described here and in the table below. The *first* record shall contain fields indicating the manufacturer, style, and type of lens using the first eight fields defined in Section 3.2: **MFG, Category, Class, Description, Material, Material Brand, Product Name**, and **Style**. The *second* record shall be a header row containing *all* of the field labels, as indicated below.

The following data field entries shall be provided in the order shown below. The field’s label—as it should appear in the file—is provided, as well as a description / definition of the field, the type of entry data that should be supplied in the field, and any *literal* entries that should appear in the field. Certain fields may not be applicable for all lens styles, and should be left blank (that is, “,”). Fields that shall generally require an entry for most, though not necessarily all, spectacle lenses of any style or type have been indicated in the “?” column with the letter ‘M’ for *mandatory*. For instance, the **Add** and **Angle** fields are not applicable to *rotationally-symmetrical* surfaces, like single vision lenses.

#	?	Field Label	Description / Definition	Literals	Data Type
1	M	Base	Nominal base curve		Numeric, 2-decimal
2		Add	Add power (when applicable)		Numeric, 2-decimal
3	M	Radius	Incremental radius (mm), ≥15		Numeric, 2-decimal
4		Angle	Incremental angle (°), ≥000		Numeric, 2-decimal
5	M	Sag	Sag height at radius and angle		Numeric, 2-decimal

4.1.1. Sag height data for general (non-rotationally-symmetrical) surfaces

General (or *non-rotationally-symmetrical*) surfaces, like those used for progressive addition lenses, require both radius and angular sag data. In the case of multifocal or progressive lenses whose sag height data vary from add power to add power, the sag height data for each individual add power are also required. The hierarchy of levels for this data shall be:

1. For each base curve, add power (when applicable), and radius, sag heights for every angle
2. For each base curve and add power, sag heights for every radius—at every angle
3. For each base curve, sag heights for every add power—at every radius and angle

Starting with the lowest nominal base curve, add power, incremental radius, and incremental angle value, the sag height data shall be provided in the following tabular format:

Base	Add	Radius	Angle	Sag
1 st Base	1 st Add	1 st Radius	1 st Angle	Sag Height
1 st Base	1 st Add	1 st Radius	n th Angle	Sag Height
1 st Base	1 st Add	n th Radius	1 st Angle	Sag Height
1 st Base	1 st Add	n th Radius	n th Angle	Sag Height
1 st Base	n th Add	1 st Radius	1 st Angle	Sag Height

Base	Add	Radius	Angle	Sag
1 st Base	n th Add	1 st Radius	n th Angle	Sag Height
1 st Base	n th Add	n th Radius	1 st Angle	Sag Height
1 st Base	n th Add	n th Radius	n th Angle	Sag Height
n th Base	1 st Add	1 st Radius	1 st Angle	Sag Height
n th Base	1 st Add	1 st Radius	n th Angle	Sag Height
n th Base	1 st Add	n th Radius	1 st Angle	Sag Height
n th Base	1 st Add	n th Radius	n th Angle	Sag Height
n th Base	n th Add	1 st Radius	1 st Angle	Sag Height
n th Base	n th Add	1 st Radius	n th Angle	Sag Height
n th Base	n th Add	n th Radius	1 st Angle	Sag Height
n th Base	n th Add	n th Radius	n th Angle	Sag Height

Where ‘n’ simply represents the any subsequent values above 1.

4.1.2. Sag height data for rotationally-symmetrical surfaces

Rotationally-symmetrical surfaces, like those used for single vision aspheric lenses, require only radial sag data. In this case, the **Angle** and **Add** fields should be left blank (i.e., “,”). The hierarchy of levels for this data shall be:

1. For each base, sag heights at every radius

Starting with the lowest nominal base curve and incremental radius, the sag height data shall be provided in the following tabular format:

Base	Add	Radius	Angle	Sag
1 st Base		1 st Radius		Sag Height
1 st Base		n th Radius		Sag Height
N th Base		1 st Radius		Sag Height
N th Base		n th Radius		Sag Height

4.2. Guidelines for specifying sag height data

Each sag value is the height of the lens surface at a given semi-diameter (or radius) r , as measured perpendicularly from a plane tangent to the prism reference point of the lens design. This has been illustrated in Figure 17. To describe a non-spherical surface to an acceptable level of accuracy for processing and thickness calculations, multiple sag heights through a given *section* of the lens surface are required. Here, a **section** is defined as a plane perpendicular to the tangent plane and containing a given meridian (from 0° to 360°) of the lens. For *non-rotationally-symmetrical* surfaces, whose sag heights vary from meridian to meridian, data from multiple sections are also required.

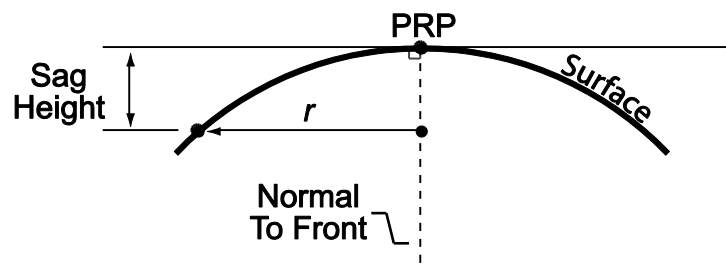

Figure 17 Sag height of lens surface at the semi-diameter r

Numeric values and text should adhere to the sign convention developed in Section 2.2.

4.2.1. For rotationally-symmetrical surfaces:

Since sag values through each meridional section of rotationally-symmetrical surfaces are equal, no particular orientation needs to be expressed or implied.

The radial (or tangential) sag values of rotationally-symmetrical surfaces shall be given in 2.5-mm radial increments, beginning 15.0 mm from the prism reference point (PRP) of the lens design. See Figure 18.

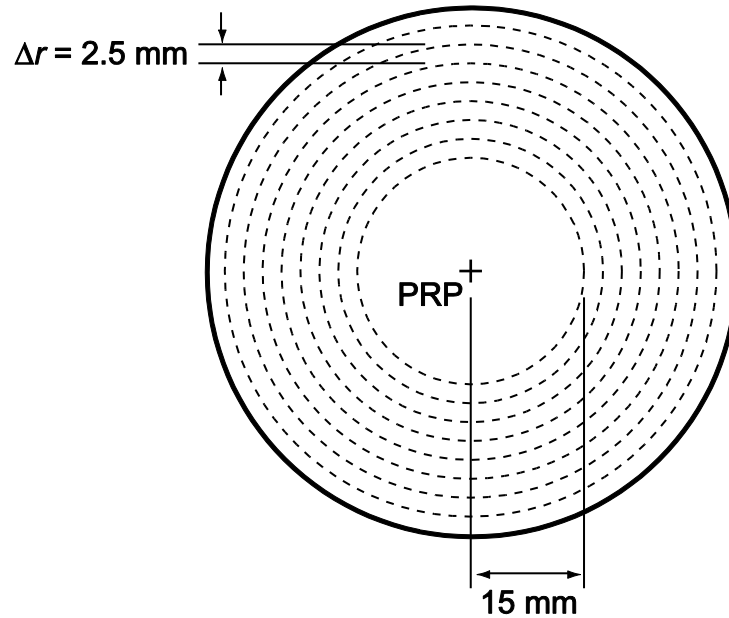

Figure 18 Radial measurement increments (Δr) for surfaces

4.2.2. For non-rotationally-symmetrical surfaces:

The sag heights of non-rotationally symmetrical surfaces shall be given for meridional sections in 15° angular increments, beginning from the 000° (nasal) meridian of the *right* lens and terminating at the 345° meridian. This has been illustrated in Figure 19.

The radial (or tangential) sag heights through each meridional section of non-rotationally-symmetrical surfaces shall be given in 2.5-mm radial increments, beginning 15.0 mm from the prism reference point (PRP) of the lens design.

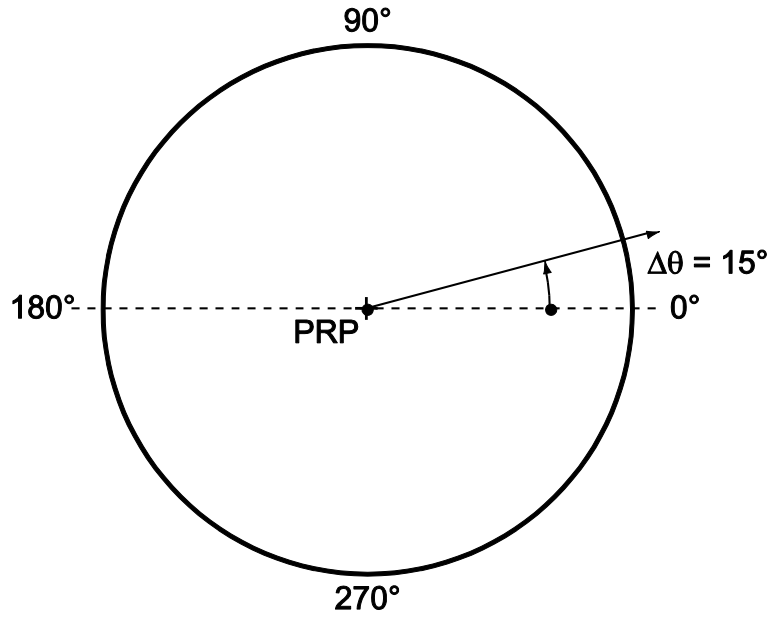

Figure 19 Angular measurement increments ($\Delta\theta$) for general (non-rotationally-symmetrical) surfaces

5. Standard File Format Examples

The examples below should serve as paradigms for creating and disseminating the lens specification and surface description files described in this Standard.

5.1. File examples for describing lens blank specifications and attributes

The following represents what a file fragment of lens specification data might look like for a typical manufacturer:

MFG,	Class,	Description,	Material,	Material Brand,	Product Name,	...
"SOUSA",	"SFN",	"Percepta Spect Trans",	"PM",	"Spectralite",	"Percepta",	...
"SOUSA",	"SFN",	"Percepta Hard Resin",	"PL",	"CR39",	"Percepta",	...
"SOUSA",	"FNT",	"SV VIZIO 1.66",	"PU",	"MR7",	"SV VIZIO",	...
"SOUSA",	"FIN",	"SV Transitions Gray",	"PL",	"CR307",	"Transitions Gray",	...
"SOUSA",	"SFN",	"FT35 Bifocal Hard Resin",	"PL",	"CR39",	"FT35 Bifocal",	...
"SOUSA",	"SFN",	"Aspheric FT28 Bifocal Poly",	"PO",	"Polycarbonate",	"Aspheric FT28",	...
"SOUSA",	"SFN",	"SV Hi-Drop",	"PL",	"CR39",	"SV Hi-Drop",	...
"SOUSA",	"SFN",	"Occupational Flattop 25/28",	"PL",	"CR39",	"Occup FT25/28",	...
"SOUSA",	"SFN",	"Glass Round Seg 22 Bifocal",	"GL",	"Crown Glass",	"Round Seg 22",	...
...

5.2. File examples for describing the geometry of non-spherical surfaces

The following represents what a file fragment of sag data might look like for a progressive addition lens with a 6.00 base curve and a +1.00 add progressive power:

Base,	Add,	Radius,	Angle,	Sag,
6.00,	1.00,	15.0,	0,	3.17,
6.00,	1.00,	15.0,	15,	3.56,
6.00,	1.00,	15.0,
6.00,	1.00,	17.5,	0,	4.01,
6.00,	1.00,	17.5,
6.00,	1.00,
6.00,	1.25,	15.0,	0,	3.20,
6.00,	1.25,	15.0,
6.00,	1.25,	17.5,	0,	4.16,
6.00,	1.25,	17.5,
6.00,	1.25,
6.00,
...

6. Literal Abbreviations

The indices below represent the lists of *literal* abbreviations currently acknowledged by the Vision Council for use in describing the technical attributes of lenses, as of the version date of this document. These abbreviations are used as literals for the Filter (**Filter**) and Manufacturer or Manufacturer brand (**MFG**) fields. To create additional abbreviations (for new products or companies), delete existing abbreviations, or to obtain the most current list of literals, please contact the Vision Council:

Michael Vitale, ABOM
The Vision Council
225 Reinekers Lane, Suite 700
Alexandria, VA 22314
(703) 548-2684
mvitale@thevisioncouncil.org

6.1. Filter Color Abbreviations (Filter)

For absorptive lenses with color, 4-character literals shall be used to identify the color and transmittance properties of the lens within the **Filter** field. The first 3 characters shall indicate the color name and the last character shall be an integer value (n) from 0 through 4 describing the transmittance or shade of the lens. This value, which is determined at the manufacturer's discretion, most commonly ranges from 1 to 3—with the lower values representing higher levels of transmittance and vice versa.

Although optional for photochromic lenses, two separate 4-character literals—separated by a space—may be used to identify the color and transmittance of the lens in both the inactivated (faded) and activated (darkened) states. When only a single 4-character literal is supplied, it shall be assumed that this literal identifies the color and transmittance of the lens in the activated (darkened) state and that the lens is clear or nearly so in the inactivated (faded) state.

Color	Literal	Example
Amber	AMB n	AMB2
Amethyst	AMT n	AMT1
Aquamarine	AQU n	AQU2
Autumn Gold	ATG n	ATG3
Blue	BLU n	BLU3
Brown	BRN n	BRN2
Copper	COP n	COP1
Didymium	DID n	DID2
Gold	GLD n	GLD3
Green	GRN n	GRN1
Green-Gray	G15 n	G153
Gray	GRY n	GRY3
Melanin	MEL n	MEL3
Pewter	PEW n	PEW1
Pink	PNK n	PNK2
Purple	PUR n	PUR3
Rainbow	RNB n	RNB2
Red	RED n	RED1

Color	Literal	Example
Rose	ROSn	ROS2
Sapphire	SAPn	SAP2
Silver	SILn	SIL3
Tan	TANn	TAN3
Therminon	THRn	THR1
Unisol	UNIn	UNI2
Yellow	YELn	YEL0
Orange	ORGn	ORG2

6.2. Manufacturer Abbreviations (MFG)

To identify uniquely the lens manufacturer or brand, a 6-character or less literal shall be provided in the **MFG** field. *Note: The below list is provided as an example only and is not intended to be a complete list.*

Company Name and Region	Literal
American Optical Corporation	AO
Augen Opticos dba; Blue Cove	AUGEN
Carl Zeiss (Germany)	ZSS
Centennial Optical	CENT
Conant	CONANT
D & D Optical Supply	WX
Essilor France	ESS
Essilor of America	ESS
Eye Solutions Inc	BLUTECH
Eyenvision	EYENV8
GKB Hitech Lenses Pvt Ltd	GKB
Hoya Corp/Hoya Lens of America	HOY
Indo Lens Group SLU	IND
Intercast Europe SRL	ICG and INT
International Lens Company	INLECO
Kaenon Polarized	KP
Kbco Polarized Lenses	KBC
Landon Lens Manufacturing Corp	LAN
Lehrer Brillen-Perfection Werks (LBI)	LBI
Lensco	LNS
Nassau Lens Company	NAS and NASSAU
Nikon Essilor Co LTD	NIKON
Optima, Inc	OPT
Pentax Vision	PNT
Polycore Optical Pte Ltd	POUSA
Prio Corporation	PRIO
Private Label Optical	SLIM N LITE
Rodenstock Germany	ROD

Company Name and Region	Literal
Rozin Optical International LLC	ROZIN
Scopus Optical Industry	SCOPUS
Seiko Optical Products	SKO
Shamir Insight Inc.	SHAMIR
Shore Lens	SHORE and SHO
Signet Armorlite	SAUSA ans SA
Silor/Essilor	ESS
Sola Optical USA, Inc	SOUSA
Somo Optical	SOMUSA and SOM
Specialty Lens Corp/Essilor	SLC
Techtran Polylenses LTD	TPL
Thai Optical Group Public Co	TOG
Tokai Optical Co Ltd	TOKAI
UVCO (United Vision Corp)	UVCO
Varilux/Essilor	VAR
Vision Dynamics	PT
Vision Warehouse LLC	VW
Vision-Ease Lens	VE
X-Cel Optical	XCL
Younger Optics	YNG

END